

SERVICE & OPERATING MANUAL AIR OPERATED DOUBLE DIAPHRAGM PUMP

B15 & X15

All Aluminium Models Inc. Lube Free

This pump is Atex approved for use
in potentially explosive atmospheres
Group II category 2



Table of Contents

Service / Maintenance Log, Recycling	2
Dimensions	3
Performance Curve	3
Technical Data & Temperature limitations	4
Explanation of Pump Nomenclature	4
Principle of Pump Operation	5
Installation guide	5
Important Warnings & Safety Information	6
Troubleshooting	7
Grounding the Pump.....	7
Warranty	8
Service	8
Air Valve Overhaul	8
Wet-side Overhaul	8
Exhaust Safety	9
High Temperature Inst.....	9
Parts List	10
Assembly Drawing	11
Declaration of Conformity	12



Service / Maintenance Log

Date	Details	Completed



RECYCLING

Many components of BLAGDON air operated double diaphragm pumps are made of recyclable materials. We encourage pump users to recycle worn out parts and pumps whenever possible, after any hazardous pumped fluids are thoroughly flushed.

Contact Information

Contact	Phone / Fax No.

GA Drawing & Performance Curve

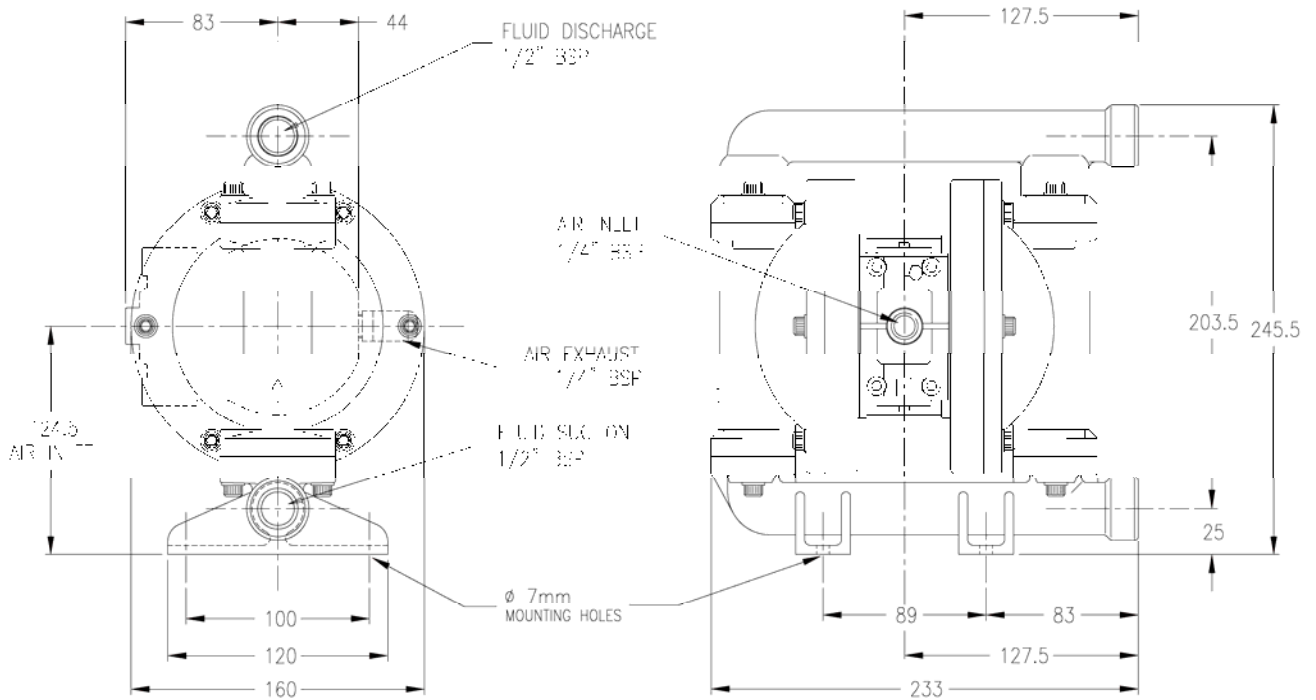

General Assembly :- B15 Aluminium pump, all dimensions +/- 2mm

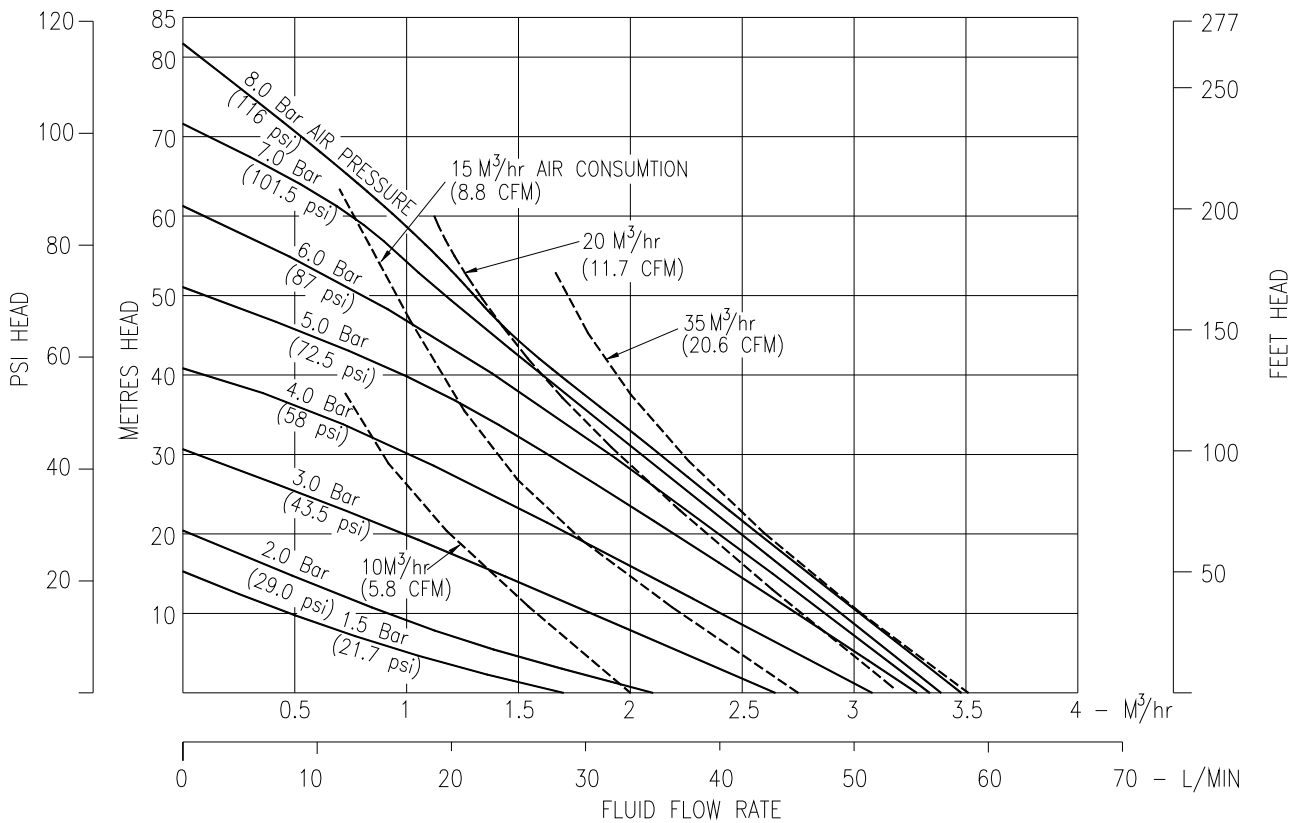

B15 & X15 Aluminium Pump Performance Curve, performance based on water at ambient temperature

TECHNICAL DATA				
FLUID CONNECTIONS 1/2" BSP	CAPACITY 0 - 58 Litres/Minute (0 - 12.7 Gallons/Minute)	MAX SOLIDS 2 MM (5/64")	MAX DISCHARGE HEAD 88 Meters (289 ft)	DISPLACEMENT/STROKE 0.075 Litres (0.02 UK Gallons)
MAX. WORKING PRESSURE 8.6 Bar (125 psi)	AIR INLET 1/4" BSP (F)	TEMPERATURE LIMITS Determined by Elastomers		PUMP WEIGHTS :- AA :- 4.8 Kg

ⓘ Caution - Operating temperature limitations are as follows:

Materials	Operating Temperatures		
	Maximum	Minimum	Optimum
Buna-n - General purpose, oil resistant. Shows good solvent, oil, water and hydraulic fluid resistance. Should not be used with highly polar solvents like acetone and MEK, ozone, chlorinated hydrocarbons and nitro hydrocarbons.	176°F 80°C	-18°F -28°C	50° to 140°F 10° to 60°C
EPDM - Shows very good water and chemical resistance. Has poor resistance to oils and solvents, but is fair on ketones and alcohols.	212°F 100°C	-11°F -24°C	50° to 212°F 10° to 100°C
Neoprene - All purpose. Resistant to vegetable oil. Generally not affected by moderate chemicals, fats greases and many oils and solvents. Generally attacked by strong oxidising acids, ketones, esters, nitro hydro carbons and chlorinated aromatic hydrocarbons.	212°F 100°C	-4°F -20°C	50° to 130°F 10° to 54°C
Santoprene® - Injection moulded thermoplastic elastomer with no fabric layer. Long mechanical flex life. Excellent abrasion resistance.	212°F 100°C	-10°F -23°C	50° to 212°F 10° to 100°C
Virgin PTFE - Chemically inert, virtually impervious. Very few chemicals are known to react chemically with PTFE : molten alkali metals, turbulent liquid or gaseous fluorine and a few fluoro-chemicals such as chlorine trifluoride or oxygen difluoride which readily liberate free fluorine at elevated temperatures.	356°F 180°C	32°F 0°C	50° to 212°F 10° to 100°C
Viton® - Shows good resistance to a wide range of oils and solvents : especially all aliphatic, aromatic and halogenated hydrocarbons, acids, animal and vegetable oils.	356°F 180°C	0°F -18°C	75° to 212°F 24° to 100°C
Polypropylene - High strength, light weight, corrosion resistant polyolefin which easily withstands most chemicals, with no known solvent at room temperature.	158°F 70°C	-40°F -40°C	50° to 140°F 10° to 60°C

TYPICAL CODE = B15.01.A A. B B. E T S - L F

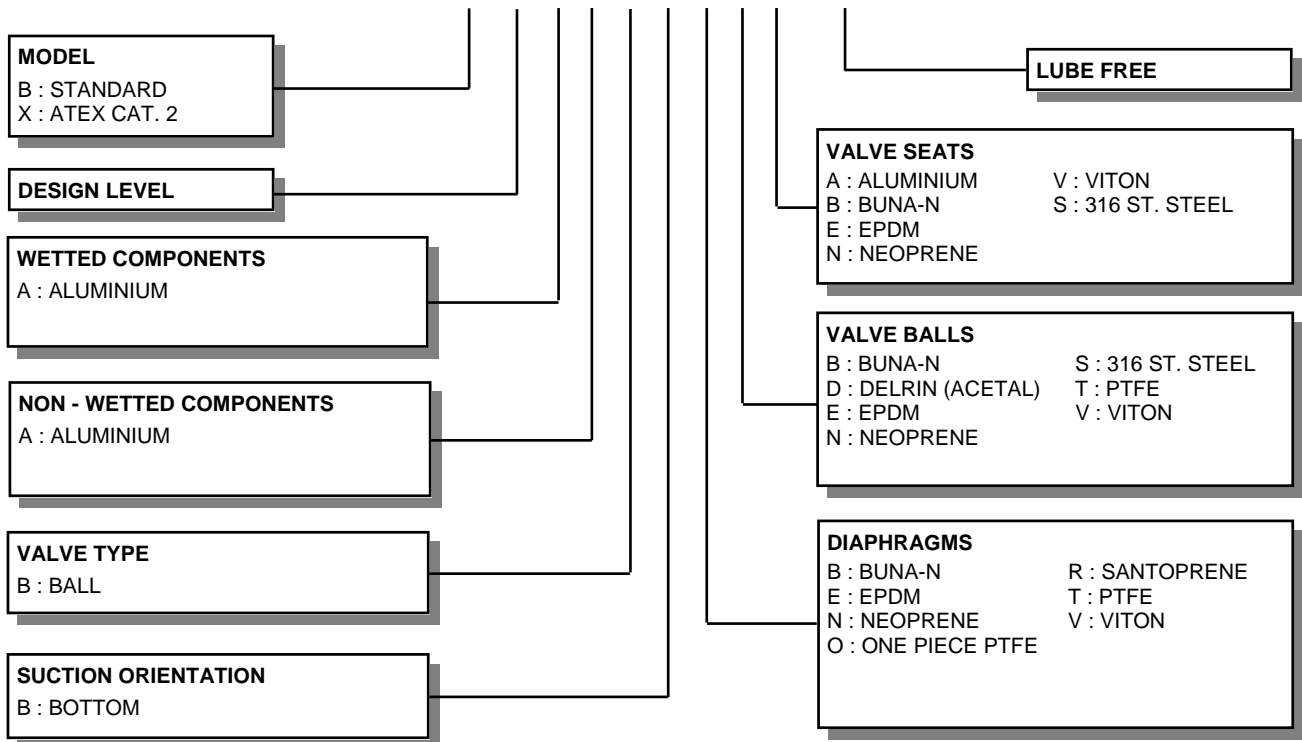

IMPORTANT

This pump should be used in accordance with the requirements of the Safety, Health & Welfare at Work Act 2005. All business conducted subject to IDEX Pump Technologies, Ireland. Terms and Conditions of Sale, available on request.



IDEX Pump Technologies (Ireland) Ltd.,
A Unit of IDEX Corporation,
R79, Shannon, Co Clare, IRELAND
TEL. : +353 61 471933 FAX. : +353 61 475046
Web Site : www.blagdonpump.com
E-Mail : sales@blagdonpump.com

PRINCIPLE OF PUMP

OPERATION

This ball valve type diaphragm pump is powered by compressed air and is a 1:1 ratio design. The inner side of one diaphragm chamber is alternately pressurised while simultaneously exhausting the other inner chamber. This causes the diaphragms, which are connected by a common shaft secured by plates to the centres of the diaphragms, to move in a reciprocating action. (As one diaphragm performs a discharge stroke the other diaphragm is pulled to perform the suction stroke in the opposite chamber.) Air pressure is applied over the entire inner surface of the diaphragm while liquid is discharged from the opposite side of the diaphragm. The diaphragm operates in a balanced condition during the discharge stroke which allows the pump to be operated at discharge heads of over 200 feet (61 meters) of water.

For maximum diaphragm life, keep the pump as close to the liquid being pumped as possible. Positive suction head in excess of 10 feet of liquid (3.048 meters) may require a back pressure regulating device to maximize diaphragm life.

Alternate pressurising and exhausting of the diaphragm chamber is performed by an externally mounted, pilot operated, 2 way type distribution valve. When the spool shifts to one end of the valve block body, inlet pressure is applied to one chamber and the other diaphragm chamber exhausts. When the spool shifts to the opposite end of the valve body, the pressure to the chambers is reversed. This alternating

movement of the spool inside the valve body is controlled by a pilot air pressure signal held against the diaphragm shaft, between seals in the diaphragm shaft bushes. This signal is released, triggering the movement of the spool, when pilot holes in the diaphragm shaft align with the held pilot signal, sending the signal to exhaust, which in-turn causes a pressure imbalance around the spool, sending it to the opposite end of the valve body. This simultaneously sends inlet pressure to the opposite chamber.

The chambers are connected by manifolds with a suction and discharge ball valve for each chamber, maintaining flow in one direction through the pump.

INSTALLATION

The typical installation shown in FIG. 1 is only a guide to selecting and installing system components. Your installation will depend on the type of fluid being pumped and your application needs. To reduce the risk of serious bodily injury and damage to property, never use fluids in this pump which are not compatible with the wetted components. Contact your local distributor or the manufacturer for system design assistance & compatibility if necessary.

Mount the pump in an upright position. Failure to ensure an upright position may result in loss of or poor priming characteristics. Ensure the pump is securely mounted to avoid movement and possible risk of bodily injury.

PRESSURE The pump delivers the same pressure at the discharge outlet as the air pressure applied at the air inlet (unless pump is

configured as a 2:1 ratio model).

NOTE: *Pressure Regulator (H) should be installed where air supply could exceed 125 psi.*

SAFETY

Your **BLAGDON PUMP** is a high performance unit capable of achieving high outputs at high efficiencies. However, as is common with pneumatic equipment, the pump efficiencies is reliant upon the air being clean, dry and filtered. Failure to comply with these requirements may lead to loss of performance and reduced component life and in extreme cases, permanent damage to the pump.

To avoid leaks, ensure that all fluid connections are tight. The use of PTFE thread tape correctly applied should be used to ensure 100% leak proof connections. **Failure to ensure 100% sealability of the suction connection could adversely affect suction performance.**

If you are pumping hazardous fluids, or operating the pump in an enclosed area, it is essential that the exhaust from the pump is piped away to a safe location. When pumping hazardous fluids the above instructions must be adhered to in order to ensure safe operating procedures. (Under certain operating conditions the failure of internal components can lead to the pumped fluid being exhausted via the pump exhaust outlet).

WARNING

NEVER place your hands over or near the pump suction inlet. Powerful suction could cause serious bodily injury.

FLUSH THE PUMP This pump was tested with water containing an oil-based rust inhibitor. If this solution could contaminate or react with the fluid you are pumping, flush the pump thoroughly with a solvent/detergent to clean internal components. The solvent/detergent must be compatible with the pump materials of construction. Care should be taken to flush the pump each time it is disassembled for maintenance or repair.

CAUTION

All **BLAGDON PUMPS** are built lubricated with grease during assembly and need no further lubrication. If the use of oil cannot be avoided, this will not present any problems. A light No. 2 class lithium grease is recommended. Other grades may cause the Air Logic System to operate intermittently, thereby causing a loss of output and failure to operate. Other seals are available for "clean room" conditions

If the pump accelerates or is running too fast due to a lack of fluid, then stop it immediately by shutting off the air supply. A dry pump will accelerate to a high speed causing wear to elastomers.

If the fluid you are pumping tends to dry up or set when it is not moving, then flush the pump as often as necessary to prevent the fluid from drying in the pump. Drain the pump thoroughly before storing.

If feasible, invert pump to allow any fluid to drain from the non-return valves.

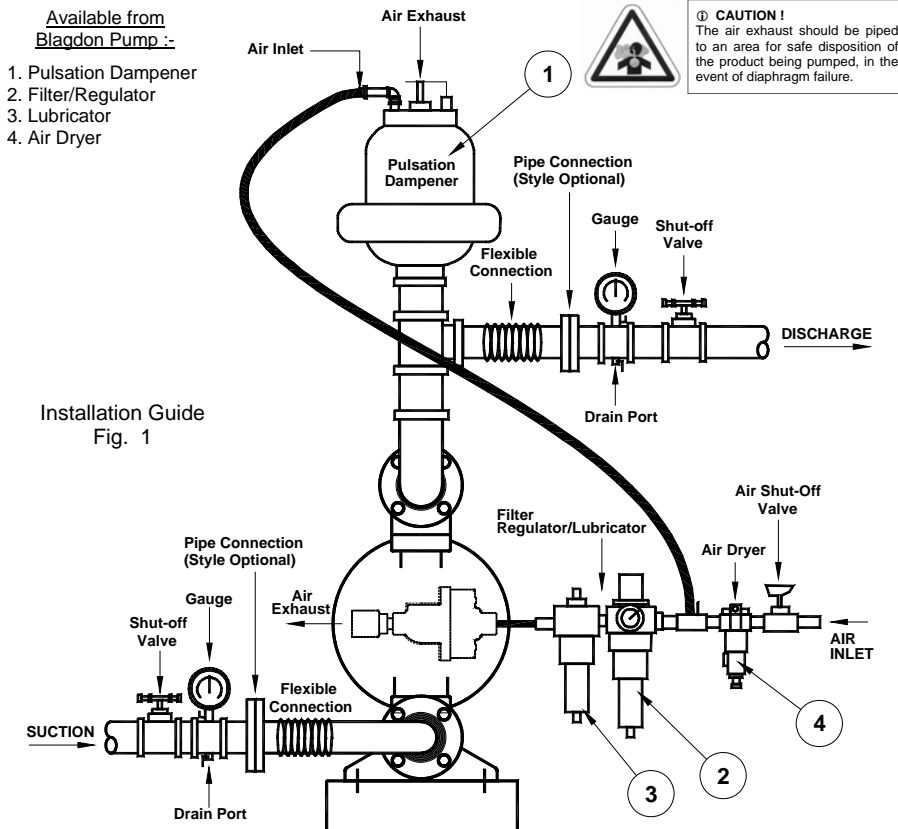

Installation Guide
Fig. 1

Important Warnings and Safety Information



IMPORTANT

Read these safety warnings and instructions in this manual completely, before installation and start-up of the pump. It is the responsibility of the purchaser to retain this manual for reference. This manual must be kept with, and supplied with the pump at all times. Failure to comply with the recommendations stated in this manual will damage the pump, and void factory warranty. These instructions are available if required, in the language or languages of the country or countries in which the equipment is used. Please refer to the manufacturer for details.



IMPORTANT!

This pump is pressurized internally with air pressure during operation. Always make certain that all bolting is in good condition and that all of the correct bolting is reinstalled during assembly. End-user must ensure correct fitting of Inlet / Outlet connections. Crossed threads or over tightening of connections will result in leaks. Quick action/release connections are not recommended. If their use is unavoidable, the levers must be locked to avoid them being forced apart in a hazardous manner.



WARNING!

Before maintenance or repair, shut off the compressed air line, bleed the pressure, and disconnect the air line from the pump. The discharge line may be pressurized and must be bled of its pressure. End-user must ensure correct regulation of air supply pressure, as any increase in air pressure results in a similar increase in product pressure if stalled-out.



WARNING!

Before doing any maintenance on the pump, be certain all pressure is completely vented from the pump, suction, discharge, piping, and all other openings and connections. Be certain the air supply is locked out or made non-operational, so that it cannot be started while work is being done on the pump. Be certain that approved eye protection and protective clothing are worn at all times in the vicinity of the pump. Failure to follow these recommendations may result in serious injury or death.



WARNING!

Airborne particles and loud noise hazards. Wear ear and eye protection.



WARNING!

Take action to prevent static sparking. Fire or explosion can result, especially when handling flammable liquids. The pump, piping, valves, containers or other miscellaneous equipment must be grounded. Refer to exhaust safety instructions on page 9.



WARNING!

When used for toxic or aggressive fluids, the pump should always be flushed clean prior to disassembly. User must ensure chemical compatibility, and any pressure / temperature limits are not exceeded. These instructions include all the information for relevant diaphragm temperature limits. Pump temperature range can also be found on data-plate attached to the pump. If pump is not used for more than 5 days, care must be taken when restarting. If in any doubt, remove pump from line and flush with a suitable cleaner. Solidified deposits within the pump may cause damage to the diaphragms.



CAUTION!

Before pump operation, inspect all gasketed fasteners for looseness caused by gasket creep. Re-torque loose fasteners to prevent leakage. Follow recommended torques stated in this manual. In cases of excess vibration, Blagdon recommend fitting a Pulsation Dampener to remove effects of pulse actions from pump operation. Flexible connections can be used, but must be kept to a minimum length necessary to avoid sharp flexing or straining movements.

TROUBLE SHOOTING GUIDE

NOTE :- Check all solutions before dismantling the pump.

PROBLEM	CAUSE	SOLUTION
Pump will not start	Air valve assembly malfunction/Seizure Obstructed fluid line. Obstructed diaphragm chamber. Diaphragm failure causing fluid & excessive air to be expelled through the exhaust. Diaphragm shaft seal failure. Air valve system malfunction. Air connected to exhaust.	Check carrier for freedom of movement. - Clean, oil & replace. Clean line or increase line size. Remove obstruction. Replace diaphragm. Replace shaft seals. Check all seals in valve chest assembly. Re-connect to air inlet.
Erratic flow	Diaphragm failure on one side. Valve ball not seating. Suction leakage. Diaphragm failure causing fluid & excessive air to be expelled through the exhaust. Diaphragm shaft seal failure. Air valve system malfunction.	Replace diaphragm. Check and remove obstruction. Check and correct. Replace diaphragm. Replace shaft seals. Check all seals in valve chest assembly.
Pump strokes but will not discharge	Excessive suction lift. Suction line leakage. Valve ball not seating correctly or damaged. Suction line or strainer clogged. Diaphragm failure.	Shorten suction line. Check and correct. Check and remove obstruction / replace. Clear. Replace diaphragm.
Fluid discharged from air exhaust	Diaphragm Failure. Loose frontplate.	Replace diaphragm. Re-Torque to manual specifications.
Intermittent stroke rate	Over lubrication Diaphragm shaft seal failure. Air valve system malfunction. Valve ball not seating / partially obstructed.	Shut-down pump. Remove air connection into pump & introduce a small quantity of degreasing agent into air valve and replace line. Run pump until clear. Replace seals. Check all seals in valve chest assembly. Clear obstruction.

ATEX Certified units :- X1501AA.. These models are certified to :-  II 2 GD c

Non-electrical equipment for potentially explosive atmospheres : EN13463-1 : 2001, 'c' - Internal control of production.

Grounding the pump :-



WARNING!

Take action to prevent static sparking. Fire or explosion can result, especially when handling flammable liquids. The pump, piping, valves, containers or other miscellaneous equipment must be grounded.

The ATEX approved units are supplied with a natural earth ground cable. This cable is 2 meters in length and permanently connected through a nut and bolt at the inner cover casting. The other end is free to connect to the nearest available suitable point to provide a natural earth ground. This must be done to reduce the risk of electro-static sparking.

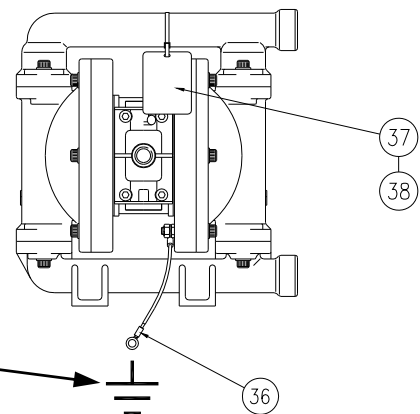

ADDITIONAL PARTS FOR ATEX CAT. 2 PUMPS (see also page 10)			
REF No.	PART NUMBER	DESCRIPTION	QTY
36	SA10289	GROUNDING LEAD	1
37	SP467	ATEX I/D TAG	1
38	SP472	TIE-LOK TIE	1



IMPORTANT!

Read these instructions completely, before installation and start-up. It is the responsibility of the purchaser to retain this manual for reference. Failure to comply with the recommendations stated in this manual will damage the pump, and void factory warranty.

SERVICE

The following sections give a general overview on how to service all models of BLAGDON Diaphragm Pumps. For details on individual part numbers, quantities, materials, etc., please consult the parts list supplied with the pump.

NOTE : *Before commencing any service or maintenance work on the pump, ensure that the air supply has been disconnected or isolated.*

AIR VALVE SYSTEMS

PNEUMATIC TYPE Remove the 4 screws securing the valve block to the valve chest, together with any associated gaskets or seals.

Remove slide valve plate & slide valve from the valve block assembly. Clean all parts thoroughly and inspect for excessive wear, replacing where necessary.

The slide valve and valve plate contact faces should be flat and free from scratches. A light polishing on a flat surface with a fine abrasive paper will remove most scratches.

If excessive wear is suspected in the valve block bore or valve carrier, remove the valve block plugs and withdraw the valve carrier. Check valve block plug o-rings for wear or attack & replace where required.

Clean the valve carrier & valve block bore with white spirits to remove any oil films.

NOTE : *The nominal diametrical clearance between the valve carrier and the valve block bore should be 0.05 - 0.09mm. A clearance in excess of this will cause the valve system to run erratically.*

Apply a light grease to the valve block plug O-rings when re-assembling into the valve block bore. Any damage to the O-ring may cause

the valve system to malfunction.

Re-assemble the valve block assembly & re-torque in accordance to the settings shown in the parts list.

In the event of a complete air-side overhaul, the pump should be disassembled down to the centre section assembly as described later in the "Wet-Side Overhaul" section.

With the valve block assembly dismantled, remove the inner covers where appropriate.

A careful note of the position of all related seals and gaskets should be made to facilitate re-assembly.

Remove diaphragm shaft bushes, where appropriate, and check all seals and 'O' rings for wear or damage. If worn, replace immediately.

NOTE:- *The integrity of the diaphragm shaft seals is essential for the correct functioning of all pneumatically actuated valve systems.*

Check the diaphragm shaft for excessive wear as this will result in premature seal failure. Replace as required. Lubricate all components and re-assemble as detailed above, in reverse order. Ensure the correct position of all components detailed in all sectional assembly drawings.

WET-SIDE OVERHAUL

REPLACING BALL VALVES

Remove discharge manifold from pump assembly together with associated valve balls, seats and 'O' rings.

NOTE :- *The orientation of the valve seat relative to the valve ball should be noted as incorrect positioning may result in a performance loss.*

Turn pump through 180° and remove the suction manifold. Clean and inspect the components. Check for any wear or damage and replace as required.

NOTE :- *Ball or valve seat wear may result in loss of performance and suction lift.*

Re-assemble the valve balls/seats and ensure manifolds are adequately torqued to the settings shown in the parts list.

REPLACING DIAPHRAGMS

Remove both suction and discharge manifolds as detailed in the previous section, removing all ball valves, seats and 'O' rings.

Loosen and remove both outer covers from the pump assembly. The orientation of the covers should be noted so as to facilitate re-assembly.

Holding one of the frontplates in a vice, ('soft jaws' should be fitted), or with an adjustable spanner, loosen and remove the frontplate from the opposite end. Remove the diaphragm, backplate and bumpstop from diaphragm shaft.

Carefully withdraw the diaphragm shaft from the centre section and hold the free end in a vice, holding between the flats machined on the end. Loosen and remove the frontplate and remove the diaphragm together with backplate and bumpstop (where fitted).

NOTE :- *Care should be taken with all plastic, coated and hygienic pumps, so that the surface of the frontplate is not damaged.*

Thoroughly clean all parts and check for wear, damage, swelling, cracking, delamination and chemical attack. Replace components where required.

NOTE :- *Rubber diaphragms should be replaced if they are worn to such an extent that the fabric re-enforcing is evident on the surface of the diaphragm.*

For pumps fitted with PTFE diaphragms, a light coating of grease should be applied to the back-up diaphragm prior to re-assembly.

Before re-assembly, it is advisable to check the condition of the diaphragm shaft seal/'O' rings for wear or attack. If either is evident, it is recommended that they be replaced.

Assemble the diaphragms onto the shaft in a reverse sequence to their removal. Care should be taken as to the orientation of the diaphragm relative to the front and back plates. All diaphragms have "AIR SIDE" moulded onto one side. The backplate must be fitted adjacent to the AIR SIDE of the diaphragm.

EXHAUST SAFETY WHEN PUMPING HAZARDOUS LIQUIDS



WARNING!

In the event of diaphragm rupture, pumped material may enter the air end of the pump, and be discharged into the atmosphere. If pumping a product which is hazardous or toxic, the air exhaust must be piped to an appropriate area for safe disposition.

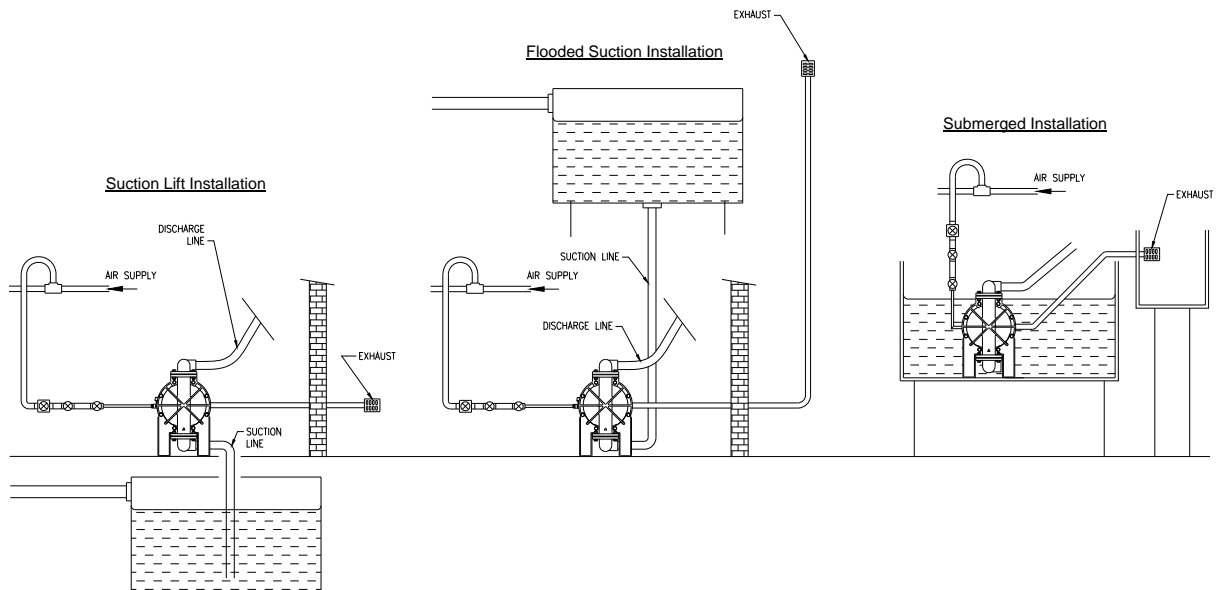

Exhaust Safety :-

When a diaphragm fails during operation, pumped liquid can enter and contaminate the air side of the pump. If diaphragm failure is not severe, i.e. a small split or hole, then the pump can continue to run, with air being forced into the product being pumped. If however the failure is more serious, then the pump may stop, with fluid or fumes being expelled through the exhaust. Under these conditions it is recommended that the exhaust is piped away to a safe area. In standard suction lift conditions this can simply be done by piping from the exhaust connection to a safe area. Multiple installations can be piped to a common connection, then to a safe area. In flooded suction conditions the exhaust must be taken to a point higher than the fluid level to prevent any siphoning away. In submerged conditions ensure exhaust is piped away above fluid level.

In all conditions ensure exhaust outlet is not expelling across a non-conductive surface. The exhaust must not be placed less than 100mm from any non-conductive surface, as this may generate a propagating brush discharge resulting in a possible ignition source.

HIGH TEMPERATURE INSTALLATIONS

In situations where the temperature of the fluid to be pumped is likely to exceed 100°C, a high temperature pump code must be specified. This is signified using an 'X' in the last part of the pump code as shown.

"XTS" in place of "TTS".

This indicates the following specification amendments :-

Diaphragm shaft seals will be changed from Polyurethane to Viton. Back-up diaphragms and any bumpstops will be changed to Viton. In extreme cases only, any gaskets could be changed to a higher temperature spec., and the diaphragm shaft bushes could be changed from plastic to metal (Contact Factory for Recommendations).

See table below for parts effected :- (refer to main table for quantities / pump)

HIGH TEMPERATURE SPECIFICATION		
REF. NO	15	22
DESCRIPTION	O-RING	SUPPORT DIAPHRAGM
MATERIAL		
VITON	G500	1H051

PARTS LIST

REF No.	PART NUMBER	DESCRIPTION	QTY
1	D338	SOCKET CAP SCREW M6 x 30	20
2	C007	WASHER M6	8
3	15-155	DISCHARGE MANIFOLD	1
4	SEE TABLE	VALVE BALL ◆	4
5	06-034	SILENCER	1
6	SEE TABLE	VALVE SEAT ◆	4
7	SEE TABLE	O-RING (VALVE SEAT) ◆	4
8	D215	SOCKET CAP SCREW M6 x 20	6
9	B017	NUT M6	12
10	15-158	VALVE CHEST ●	1
11	G516	O-RING □●	6
12	G517	O-RING □●	2
13	G507	O-RING □●	2
14	SA10036	DIAPHRAGM SHAFT	1
15	15-295	DIA. SHAFT SEALS (SEE TABLE FOR LUBE FREE OPTIONS) □	4
16	15-163	DIAPHRAGM SHAFT BUSH ●	2
17	G375	O-RING □●	2
18	G246	O-RING □●	4
19	15-008	OUTER COVER	2
20	SA10033	FRONTPLATE ASSEMBLY	2
21	SEE TABLE	DIAPHRAGM ◆	2
21	15-301	DIAPHRAGM - ONE-PIECE (Item 22 not used) ◆	2
22	15-219	DIAPHRAGM - BACK-UP ◆	2
23	1H114	BACKPLATE	2
24	15-009	INNER COVER ●	2
25	D260	SOCKET CAP SCREW M6 x 16	4
26	C263	WASHER - SPRING M6	4
27	15-013	VALVE BLOCK	1
28	1H009	VALVE CARRIER	1
29	G020	O-RING □	2
30	15-011	VALVE BLOCK PLUG	2
31	D322	SOCKET CAP SCREW M4 x 10	4
32	1A025	SLIDE VALVE	1
33	15-001	VALVE PLATE	1
34	15-199	GASKET □	1
35	15-156	SUCTION MANIFOLD	1

PARTS LIST - cont.

REF No.	PART NUMBER	DESCRIPTION	QTY
THE FOLLOWING PARTS ARE USED ON ATEX CERTIFIED PUMPS (see page 7)			
36	SA10289	GROUNDING LEAD ASSY. M6	1
37	SP467	ATEX I/D TAG	1
38	SP472	TIE-LOK TIE	1
5	15-258	SILENCER (REPLACES 06-034)	1

ELASTOMER TABLE

REF. No.	DESCRIPTION	O-RING	VALVE SEAT	VALVE BALL	DIAPHRAGM
MATERIALS					
BUNA-N		G251	15-002	15-017	1H011
NEOPRENE		G437	15-003	15-014	1H049
EPDM		G394	15-004	15-015	1H206
VITON		G395	15-005	15-016	1H051
PTFE		G429	-	1H017	15-033
ONE-PIECE PTFE		-	-	-	15-195
ALUMINIUM		-	15-109	-	-
STAINLESS STEEL		-	15-110	1H087	-
POLYURATHANE		-	-	-	-
DELIN		-	15-054	1H072	-
POLYESTER		-	-	-	-
SANTOPRENE®		-	-	-	15-219

LUBE FREE COMPONENTS

REF No.	DESCRIPTION	PTFE	QTY
15	O-RING (CENTRE SECTION)	15-018	4

◆ - These items are available in a recommended spares kit. Please refer to your local stockist / distributor for details.

□ - These items are available in a recommended spares kit - ASK1501 - Air side Kit
Lube Free Air Side Kit - ASK1501-LF

Santoprene is a registered trademark of Monsanto Corp.

NOTES

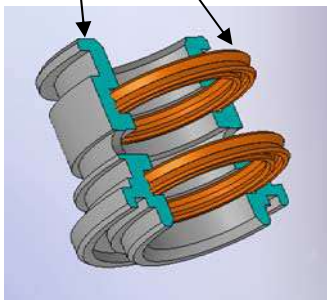

Shaft Bush, item 16.

Bi-directional Lip Seals, item 15, can be fitted either way round in grooves.

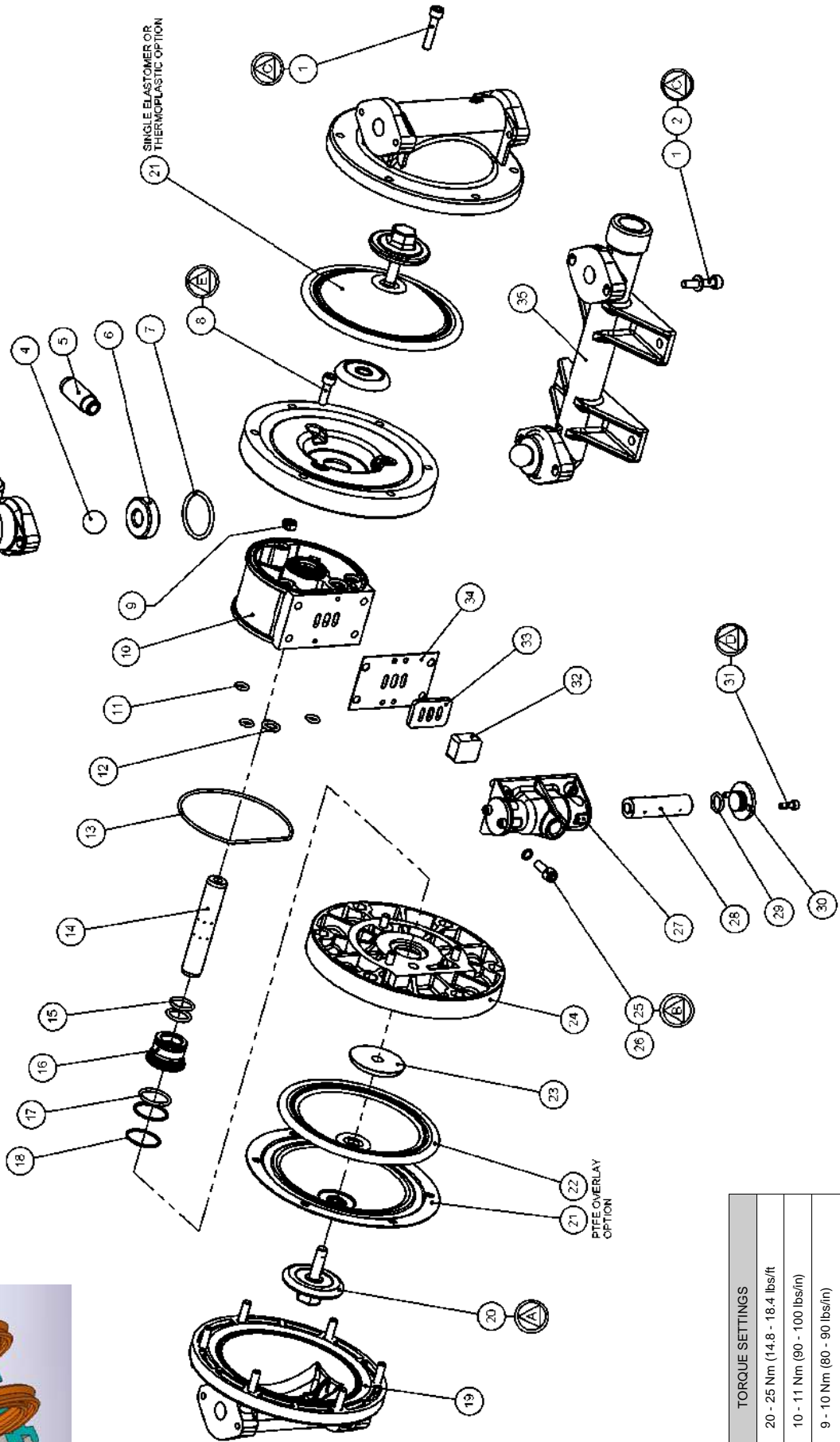

TORQUE SETTINGS	
A	- 20 - 25 Nm (14.8 - 18.4 lbs/ft)
B	- 10 - 11 Nm (90 - 100 lbs/in)
C	- 9 - 10 Nm (80 - 90 lbs/in)
D	- 3.4 - 4.5 Nm (30 - 40 lbs/in)
E	- 10 - 11 Nm (90 - 100 lbs/in)

Declaration of Conformity

DECLARATION DE CONFORMITE • DECLARACION DE CONFORMIDAD • ERKLÄRUNG BEZÜGLICH EINHALTUNG DER VORSCHRIFTEN •
DICHIARAZIONE DI CONFORMITÀ • CONFORMITEITSVERKLARING • DEKLARATION OM ÖVERENSSTÄMMELSE •
EF-ÖVERENSSTÄMMELSESERKLÄRING • VAATIMUSTENMUKAISUUSVAKUUTUS • SAMSVARSERKLÄRING • DECLARAÇÃO DE CONFORMIDADE •
Δήλωση Συμμόρφωσης

MANUFACTURED BY:

FABRIQUE PAR:
FABRICADA POR:
HERGESTELLT VON:
FABBRICATO DA:
VERVAARDIGD DOOR:
TILLVERKAD AV:
FABRIKANT:
VALMISTAJA:
PRODUSENT:
FABRICANTE:
Κατασκευαστής:

IDEX Pump Technologies (Ireland) Ltd.,
A Unit of IDEX Corporation,
R79, Shannon, Co Clare,
IRELAND.
TEL. : +353 61 471933
FAX. : +353 61 475046
Web Site : www.blagdonpump.com
E-Mail : sales@blagdonpump.com



PUMP MODEL TYPE

MODELE, TYPE
MODELO, TIPO
MODELL, TYPE:
MODELLO, TIPO
MALLI, TYYPI:
ΜΟΝΤΕΛΟ, ΤΥΠΟΣ:

SERIAL NO.:

NO. SERIE:
NO. DE SERIE:
SERIEN-NR.:
NUMERI DI SERIE
SERIENUMMERS:
TILLVERKNINGS NUMMER:
SERIENR.:
SARJA NO.:
SERIE NR.:
ΑΡ. ΣΕΙΡΑΣ:

This product complies with the following European Community Directives:

Ce produit est conforme aux directives de la Communauté européenne suivantes:
Este producto cumple con las siguientes Directrices de la Comunidad Europea:
Dieses produkt erfüllt die folgenden Vorschriften der Europäischen Gemeinschaft:
Questo prodotto è conforme alle seguenti direttive CEE:
Dit produkt voldoet aan de volgende EG-richtlijnen:
Denna produkt överensstämmer med följande EU direktiv:
Blagdon Pump, erklærer herved som fabrikant, at ovennævnte produkt er
i overensstemmelse med bestemmelserne i Direktive:
Tämä tuote täyttää seuraavien EC Direktiivien vaatimukset:
Dette produkt oppfyller kravene til følgende EC Direktiver:
Este produto está de acordo com as seguintes Directivas comunitárias:
Το παρόν προϊόν πληροί τις εξής οδηγίες της ΕΕ:

2006 / 42 / EC

This product has used the following harmonized standards to verify conformance:

Ce matériel est fabriqué selon les normes harmonisées suivantes, afin d'en garantir la conformité:
Este producto cumple con las siguientes directrices de la comunidad europea:
Dieses produkt ist nach folgenden harmonisierten standards gefertigt worden, die übereinstimmung wird bestätigt:
Questo prodotto ha utilizzato i seguenti standards per verificare la conformità:
De volgende geharmoniseerde normen werden gehanteerd om de conformiteit van dit produkt te garanderen:
För denna produkt har följande harmoniserande standarder använts för att bekräfta överensstämmelse:
Harmoniserade standarder, der er benyttet:
Tässä tuotteessa on sovellettu seuraavia yhdenmukaistettuja standardeja:
Dette produkt er produsert i overensstemmelse med følgende harmoniserte standarder:
Este produto utilizou os seguintes padrões harmonizados para verificar conformidade:
Το παρόν προϊόν χρησιμοποιεί τα ακόλουθα μέτρα και σταθμά εναρμονισμού για την επιβεβαίωση της συμμόρφωσης:

EN 809

AUTHORIZED / APPROVED BY:

Approuvé par:
Aprobado por:
Genehmigt von:
approvato da:
Goedgekeurd door:

Underskrift:
Valtuutettuna:
Bemyndiget av:
Autorizado Por:
Εγκρίθηκε από:

Des Monaghan,
Production & Technical Manager

Date : December 01 2009

FECHA:
DATUM:
DATA:
DATO:
ΠΑΙΝΑΥΣ:
Ημερομηνία:



HG-CF-223 (REV 6)